

# A0 Smart AC Charging Point User Manual















Please read carefully to understand the correct use of the device before installation, maintenance and operation!

Please follow the safety notes; otherwise, it may lead to a danger of death, injury and damage to the device, supplier cannot accept any liability for claims resulting from this.

### **Thank you very much to use our AC Charging Point**

- This manual describes the installation, use and maintenance of AC Charging point. This manual is intended for installation and maintenance personnel.
- The text and illustrations in this user manual are general explanations of these type of equipment, and the actual product may be inconsistent with this manual in detail.

### **Safety notes**

-  Leave no inflammable or explosive substances near the EV Charging point; otherwise, hazardous blast may result.
-  Installation and wiring should be done by personnel with professional qualification, otherwise, hazardous electric shock may result.
-  Make sure input power supply is entirely disconnected before wiring; otherwise, hazardous electric shock may result.
-  Earth terminal of the EV Charging point must be grounded securely; otherwise, hazardous electric shock may result.
-  The lead nose of the charging point must be securely attached or there is a risk of damaging the equipment.
-  Leave no metals such as bolts, gaskets into the inside of the EV Charging point; otherwise, hazardous blast and fire may result.
-  Strictly forbidden for minors or persons of restricted capacity to approach the charging point to avoid injury.
-  Forced charging is strictly forbidden when the electric vehicle or charging point fails.
-  It is strictly prohibited to use the charging point when the charging adapter or charging cables are defective, cracked, worn, broken or the charging cables is exposed. If you find any, please contact the supplier in time.
-  EV can only be charged with the engine off and stationary.
-  Accessory replacement must be done by qualified personnel, thrums or metals are prohibited to be left in the controller; otherwise, hazardous blast and fire may result.
-  It is recommended that routine safety inspection visits to charging point be conducted at least once a week.
-  Keep the charging connector clean and dry and wipe with a clean, dry cloth if soiled.

# Contents

A0 Smart AC Charging Point User Manual.....	0
1 Product Overview .....	1
1.1 Product Introduction .....	1
1.2 Specification .....	3
2 Installation.....	5
2.1 Included Mounting Parts And Required Tools .....	5
2.2 installation steps .....	5
3 Configuration .....	10
3.1 Install CP Tool App.....	10
3.2 CP Tool connect the charger.....	10
3.3 Login Configuration interface. ....	11
3.4 Parameter configuration .....	12
4 Operation.....	15
4.1 Human-Machine Interface .....	15
4.2 Charging operation .....	15
4.3 LCD Pages Description.....	16
4.4 LED indicator.....	20
5 Troubleshooting and Maintenance .....	21
5.1 Troubleshooting .....	21
5.2. Maintenance.....	21
6 Warranty agreement.....	22

---

# 1 Product Overview

## 1.1 Product Introduction

The EVSE (A0 Smart AC charging point) is an AC charging point that you can use to supply electricity to an EV. The EVSE offers tailor-made, intelligent and network charging solutions for your company or home. The EVSE can connect to the internet via WiFi, 4G or LAN. A0 series charging point share the same wallbox shell.

The model number definition of charging point follows the rules as shown in Figure 1-1

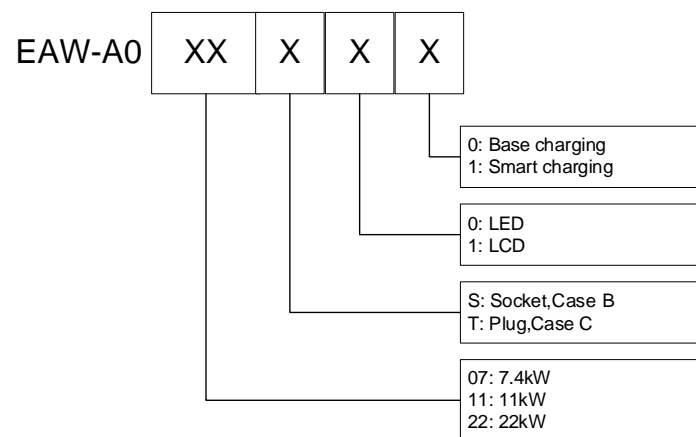

Figure 1-1

Product pictures are shown in Figure 1-2 and Figure 1-3 below:



Case B connection  
Figure 1-2 Socket Version



Case C connection  
Figure 1-3 Plug Version

## 1.2 Specification

Table 1-1 A0 series Specification

AC Power supply	EAW-A007xxx	1P + N + PE
	EAW-A011xxx,EAW-A022xxx	3P + N + PE
Rated Power	EAW-A007xxx	7.4kW
	EAW-A011xxx	11kW
	EAW-A022xxx	22kW
Rated Voltage	EAW-A007xxx	AC 230V, 50/60Hz
	EAW-A011xxx,EAW-A022xxx	AC 400V, 50/60Hz
Rated Current	EAW-A011xxx	16A
	EAW-A007xxx,EAW-A022xxx	32A
Charge system	Mode 3	
Sockets/ Plugs	EAW-A0xxSxx	Type 2 Socket, Case B connection
	EAW-A0xxTxx	Type 2 cable(5m), Case C connection
Charging Control	Smart phone APP control, Tap card control, Plug-and-charge	
Display Screen	EAW-A0xxx1x	3.5-inch LCD screen
Indicator Light	EAW-A0xxx0x	4 LED lights
Communication Interface	WiFi/BT, 4G, LAN	
Communication Protocol	OCPP 1.6J	
Safety Protection	Over current protection, over voltage protection, under voltage protection, over temperature protection, leakage protection, unconnected PE ground protection etc.	
RCD	Type B RCD (AC 30mA + DC 6mA) built-in	
Altitude	2000m	
Storage temperature	-40~75°C	
Operation temperature	-20-55°C	
Relative humidity	95%RH, No water droplet condensation	
Vibration	0.5G, No acute vibration and impaction	
Installation location	Indoor or outdoor, good ventilation, no flammable, explosive gases	
Product Weight	EAW-A022Sxx	2.5KG
	EAW-A011Sxx	2.1KG
	EAW-A007Sxx	2.0KG

	EAW-A022Txx	5.9KG
	EAW-A011Txx	4.5KG
	EAW-A007Txx	4.3KG
Dimension	EAW-A0xxSxx	Height: 455 mm Width: 260 mm Depth: 150mm
	EAW-A0xxTxx	Height: 455 mm Width: 260 mm Depth: 230mm
Mounting	Wall-mounted or pole-mounted (mounting pole is optional)	
IP Code	IP55	

## 2 Installation

### 2.1 Included Mounting Parts And Required Tools

<p>Drilling Template</p> 	<p>Insulated Cord End Terminal</p> 	<p>waterproof gaskets</p> 
<p>8 x 40 mm Wall plugs</p> 	<p>Φ5 x 40 mm Screws</p> 	

Figure 2-1 Mounting Parts







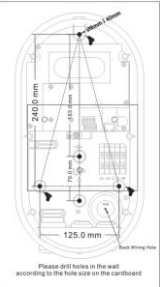
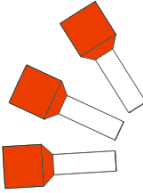
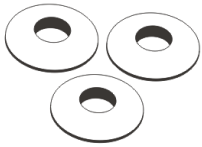
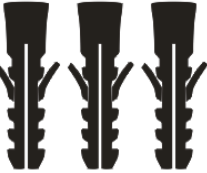
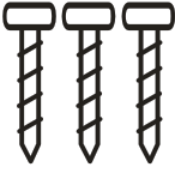

<p>Measuring Tape</p> 	<p>Electric Drill</p> 	<p>Hammer</p> 	<p>Slotted screwdriver</p> 
<p>Screwdriver (Phillips head)</p> 	<p>Wire Stripper</p> 	<p>Utility Knife</p> 	<p>Φ8mm drill bit</p> 

Figure 2-2 Installation Tools

### 2.2 installation steps

2.2.1 Cut the drilling template from the carton, place the drilling template on the wall, drill holes where the three fixing points, insert the Wall plugs into the fixing holes.



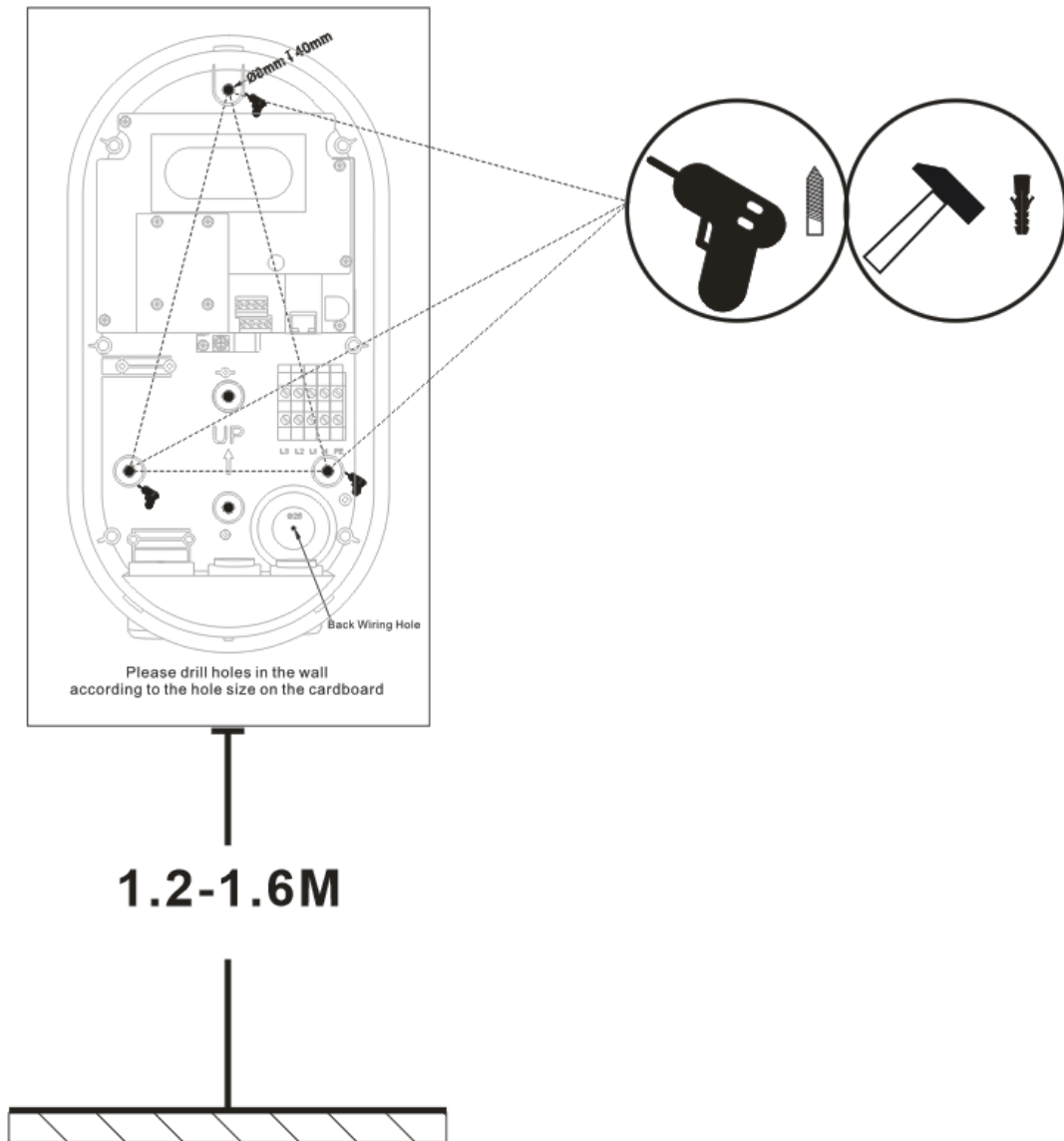
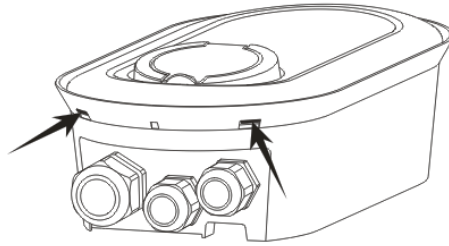
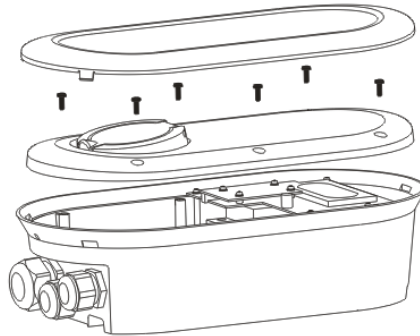

Figure 2-3 Locate the installation location

### 2.2.2 Open the cover



Press the two barbs under the machine and take out the decorative cover.



Loosen the six screws of the cover and take out the cover.

Figure 2-4 Open the cover

### 2.2.3 Fix the device on the wall by inserting the screws and waterproof gaskets

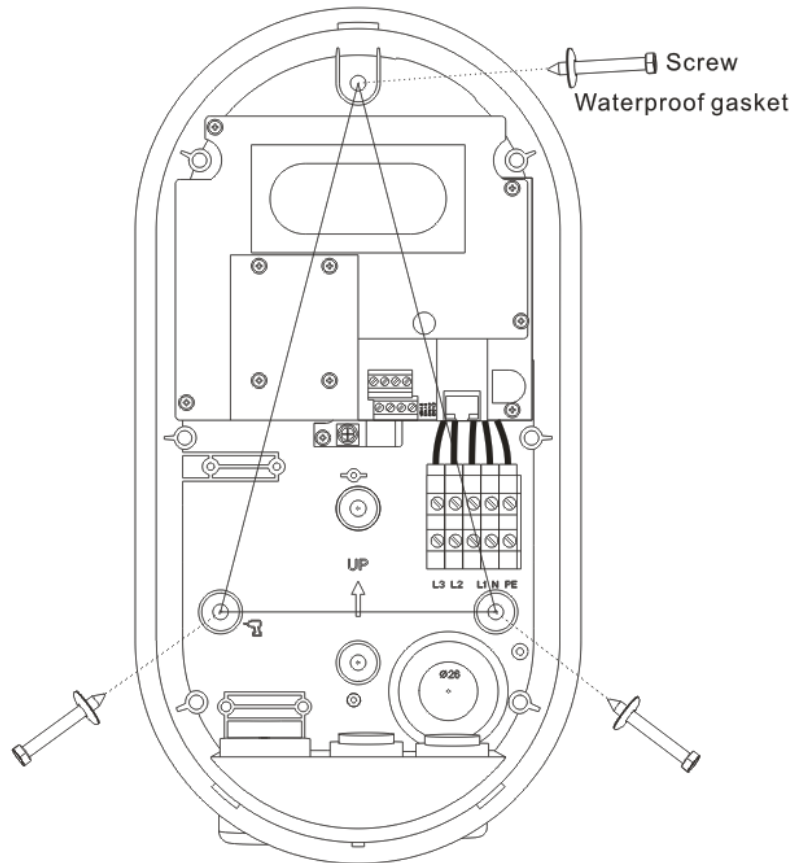

Figure 2-5 Fix the device

## 2.2.4 Wiring diagram, Electrical Wiring

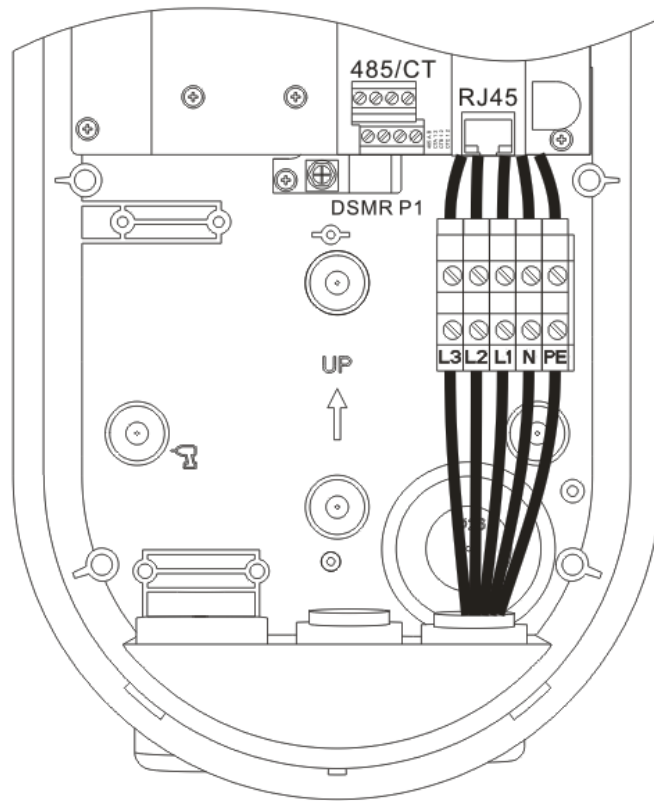

Figure 2-6 Wiring

### 2.2.5 Replace the cover

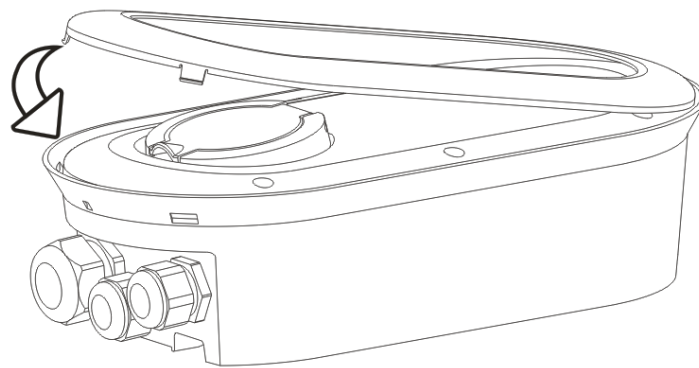

Figure 2-7 Replace the cover

Screw back the cover screws  
Buckle the upper cover.

---

## 3 Configuration

### 3.1 Install CP Tool App



Figure 3-1 Installation APP icon

Install CP Tool from Google Play or Apple Store.  
The CP Tool is used to set charger parameters.

### 3.2 CP Tool connect the charger

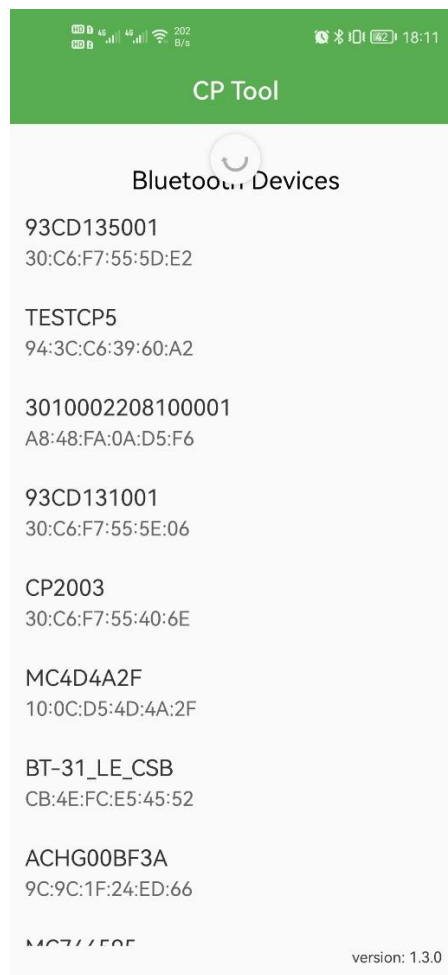

Figure 3-2 Device List Page

Open CP Tool, find the Bluetooth device corresponding to the Charger SN, and click

### 3.3 Login Configuration interface.

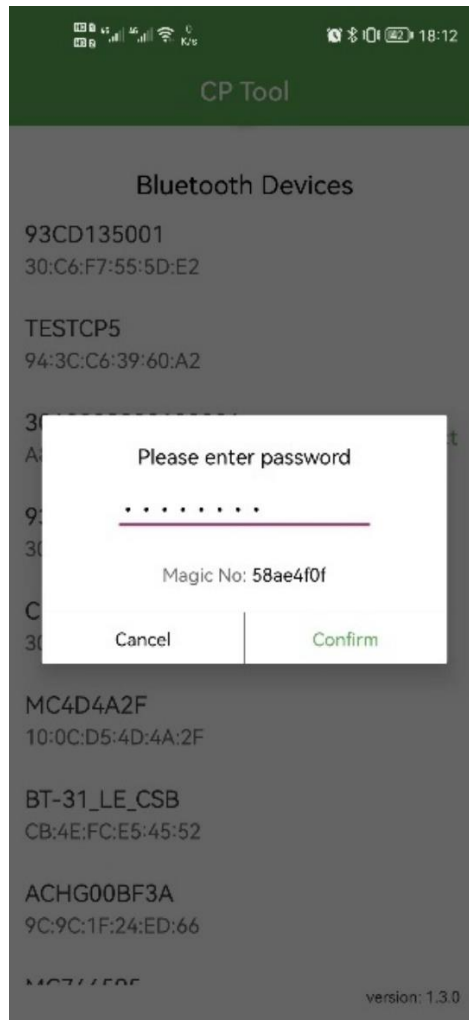

Figure 3-3 Login Page

If the connection is successful, enter the password (default password: 12345678) in the password input box and click Confirm.

### 3.4 Parameter configuration

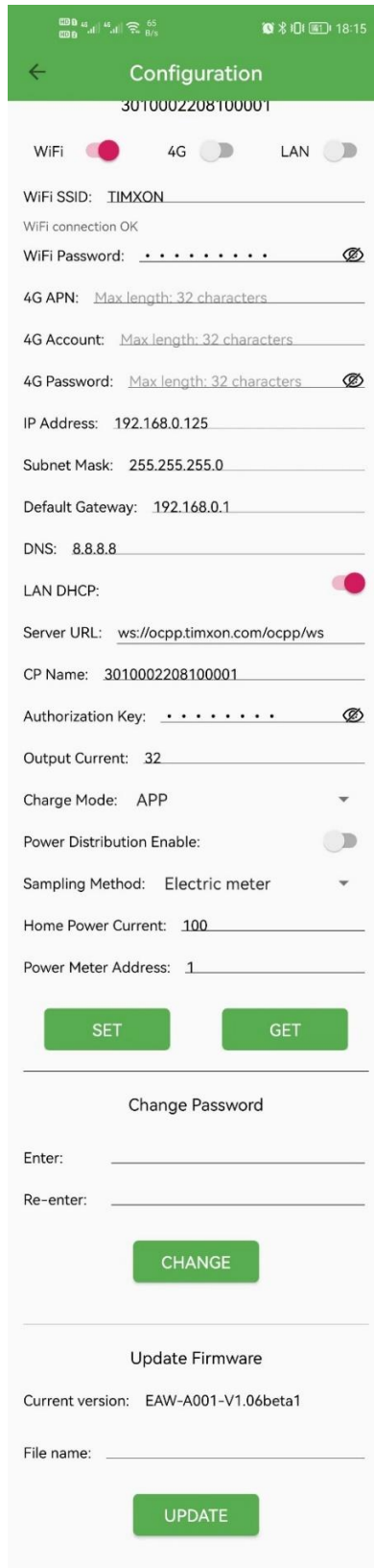

Figure 3-4 Configuration Page

---

### 3.4.1 Select Charge Mode, APP, RFID Only, Plug and Charge.

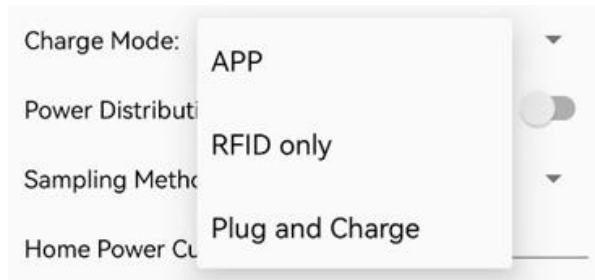

Figure 3-5 Charge Mode Options

If you select APP Mode, go to 3.4.2 to configure network parameters. If you choose RFID Only Mode or Plug and Charge Mode, you can skip the configuration of network parameters and directly start from 3.4.4.

### 3.4.2 Select communication interface: WiFi, 4G, LAN and set the parameters of the communication interface.



Figure 3-6 Network parameters

### 3.4.3 Configure the parameters related to the OCPP connection



Figure 3-7 OCPP back end parameters



---

### 3.4.4 Limit the maximum charging current



Output Current: 32

Figure 3-8 Maximum Current

### 3.4.5 Configuration DLB

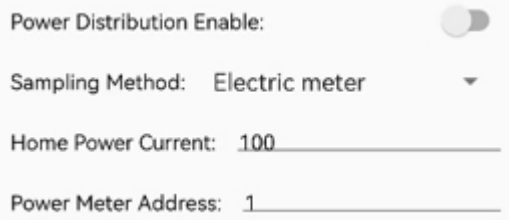

Power Distribution Enable:

Sampling Method: Electric meter

Home Power Current: 100

Power Meter Address: 1

Figure 3-9 DLB parameters

If an external CT is installed to sample current from the home grid, the DLB function can be enabled.

- \* Enabling Power Distribution Enable
- \* The Sampling Method item selects CT
- \* Home Power Current is set to a value smaller than the maximum distribution Current in the Home.

**3.4.6** After the parameters are modified, click SET, then return to the previous page, click Disconnect, and APP will disconnect the Bluetooth connection. At this time, the charger will save the configuration and restart. After restarting, the new parameters will be applied.

---

## 4 Operation

### 4.1 Human-Machine Interface



1 LCD    2 RFID reader  
3 Button    4 Connector socket

Figure 4-1 LCD Version



1 LCD    2 RFID reader  
3 Button    4 Connector socket

Figure 4-2 LED Version

### 4.2 Charging operation

#### 4.2.1 App Mode

If you use the default back end, please Install Timxon App from Google Play; if you do not use the default back end, please install the APP of the corresponding operator.

For how to use the APP, please refer to the user manual of the corresponding APP.

##### 4.2.1.1 start charging

- \* Connect EV

- \* When the charger status is available or prepare, start charging from the APP.

#### 4.2.1.2 stop charging

- \* Stop charging from APP
- \* Disconnect EV

#### 4.2.2 RFID only Mode

##### 4.2.2.1 start charging

- \* Connect EV
- \* Tap the RFID card in the RFID reader area.

##### 4.2.2.2 stop charging

- \* Tap the RFID card in the RFID reader area.
- \* Disconnect EV

#### 4.2.3 Plug and Charge Mode

##### 4.2.3.1 start charging

- \* Connect EV

##### 4.2.3.2 stop charging

- \* Press the touch button
- \* Disconnect EV

### 4.3 LCD Pages Description

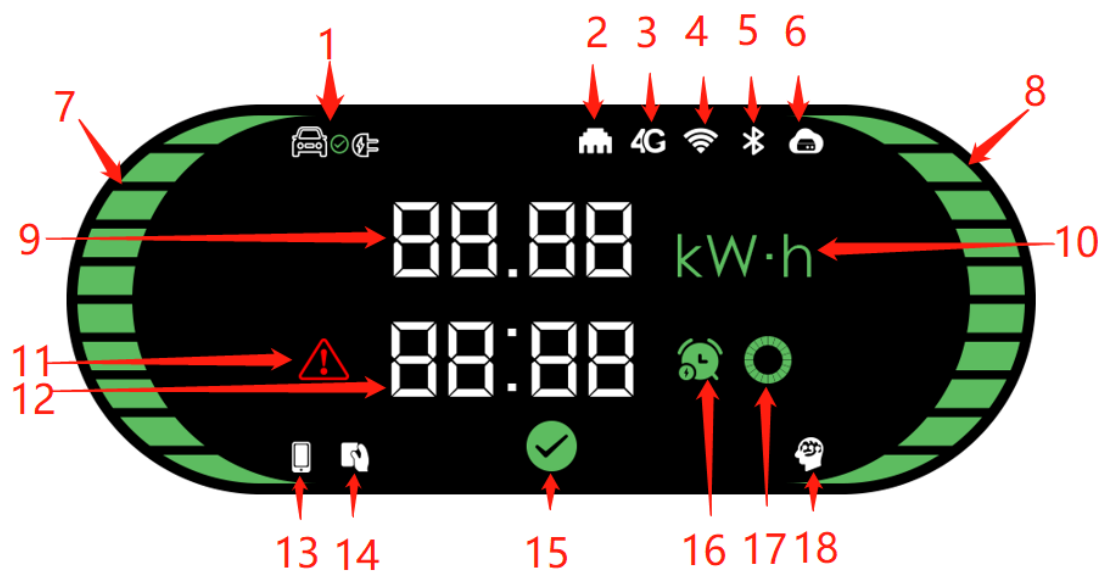

Figure 4-3 LCD General Interface

- |                   |                    |
|-------------------|--------------------|
| 1 EV connection   | 2 LAN              |
| 3 4G              | 4 WiFi             |
| 5 Bluetooth       | 6 CMS              |
| 7 Left status bar | 8 Right status bar |

9 Energy, power, or rated current

11 Fault indicator

13 Mobile APP control

15 Available indicator

17 Waiting indicator

10 Energy/Power unit

12 Time or fault code

14 RFID control

16 Reservation time indication

18 Smart Charger indicator

#### 4.3.1 Available

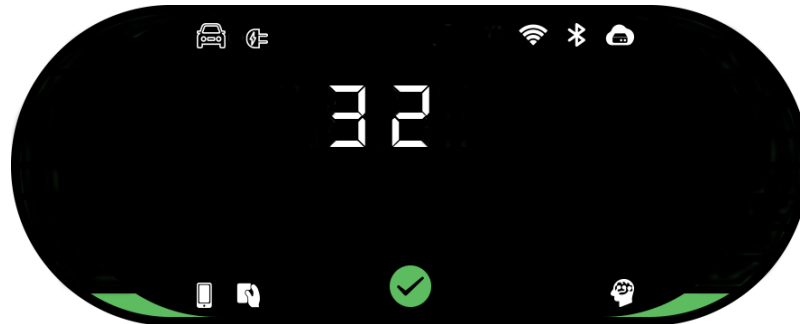

Figure 4-4 Available interface

\* Not connected to EV

\* Display rated current (A)

\* One left and right status bar indicates a single-phase charger; Three left and right status bars indicate a three-phase charger

#### 4.3.2 Prepare

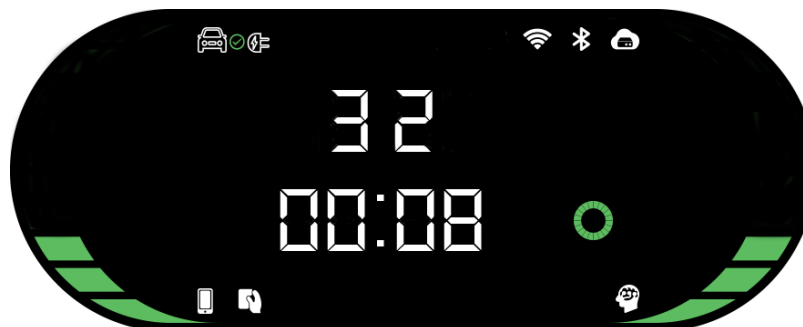

Figure 4-5 Prepare interface

\* Start charging

\* Display rated current (A)

\* Display time (minutes)

#### 4.3.3 Charging



Figure 4-6 Charging interface 1

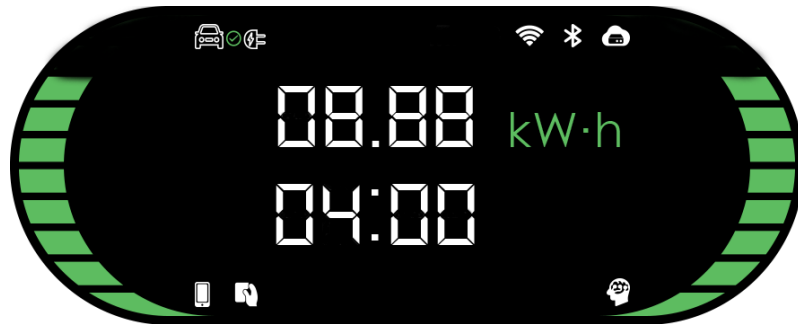

Figure 4-7 Charging interface 2

- \* Charging
- \* Display charging power (kW), charging energy (kWh) in turn
- \* Display charging time (minutes)
- \* The left and right status bars indicate charging

#### 4.3.4 Suspend

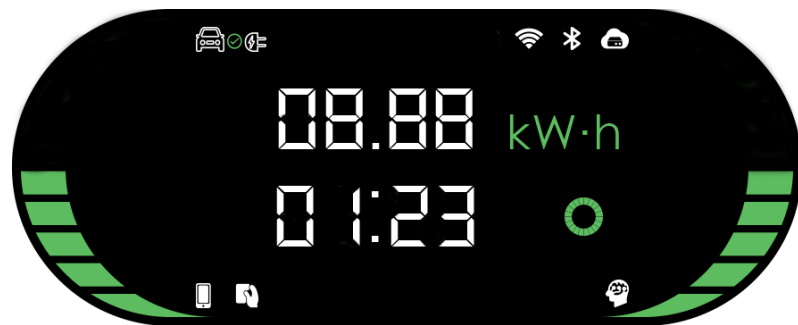

Figure 4-8 Suspend interface

- \* Charging suspend
- \* Display charging energy (kWh)
- \* Display charging time (minutes)
- \* Display Waiting indicator

#### 4.3.5 Finish



Figure 4-9 Finish interface

- \* Charging finish
- \* Display charging energy (kWh)
- \* Display charging time (minutes)

#### 4.3.6 Reserved

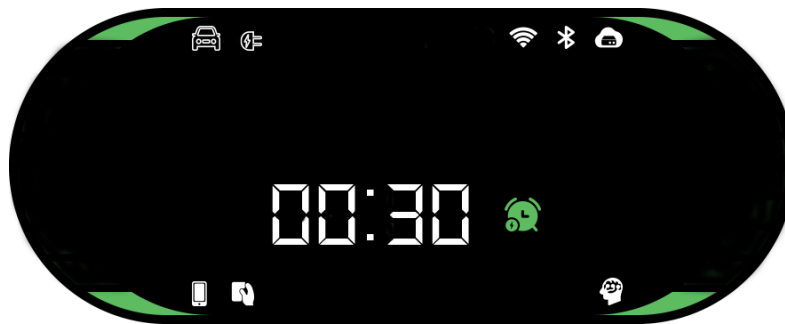

Figure 4-10 Reserved interface

- \* Reserved charging
- \* Display Reservation time (minutes)

#### 4.3.7 Fault or Unavailable

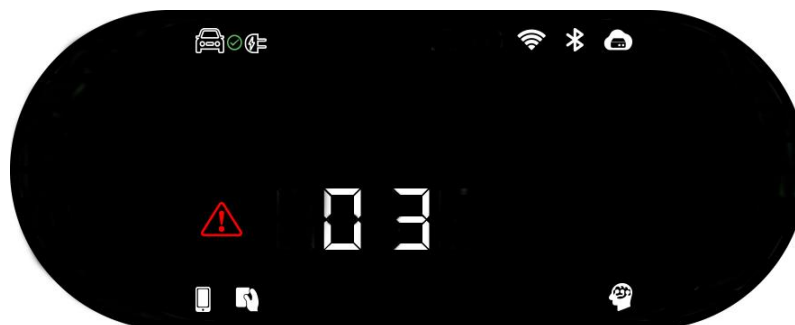

Figure 4-11 Fault interface

- \* Fault
- \* Display fault code, for the meaning of the fault, see Troubleshooting

---

## 4.4 LED indicator

Table 4-1 LED indicator

Light Status	Description
Solid Yellow	APP Mode: not connected to EV and not connected to the back end
Solid Blue	APP Mode: not connected to EV but connected to the back end RFID or Plug&Charge Mode: not connected to EV
Blue Twinkle	Connected to EV
Blue Twinkle slowly	Reservation in progress
Green streaming	Charging
Green Twinkle	Charging finished
Solid Red	Unavailable
Red Twinkle fast	Firmware update
RED flashes 1 time	Fault: fault code 1
RED flashes 2 times	Fault: fault code 2
RED flashes 3 times	Fault: fault code 3
RED flashes 4 times	Fault: fault code 4
RED flashes 5 times	Fault: fault code 5
RED flashes 6 times	Fault: fault code 6
RED flashes 7 times	Fault: fault code 7

---

## 5 Troubleshooting and Maintenance

### 5.1 Troubleshooting

Table 5-1 Troubleshooting

fault code	Fault description	Troubleshooting Suggestions
1	Leakage	<ul style="list-style-type: none"><li>• Check whether the charging connector and its cable are damaged or wet.</li><li>• Recover after pulling out the adapter.</li></ul>
2	Over Current	<ul style="list-style-type: none"><li>• Check whether the charging connector is correctly connected.</li><li>• check whether the OBC is normal</li></ul>
3	Ground disconnected	<ul style="list-style-type: none"><li>• Charging station is not grounded; input power cable needs to be checked</li></ul>
4	Overvoltage or undervoltage	<ul style="list-style-type: none"><li>• Check whether the input cable is reliably</li><li>• Check whether the input voltage is abnormal.</li></ul>
5	Contacting welding or breaking	<ul style="list-style-type: none"><li>• Check whether the contactor connection is reliable.</li></ul>
6	CP abnormal	<ul style="list-style-type: none"><li>• Check the charging connector and charging socket of EV.</li><li>• Disconnect and reconnect the charging connector</li></ul>
7	electronic lock fault	<ul style="list-style-type: none"><li>• Check that the electronic lock connection is reliable.</li></ul>

### 5.2. Maintenance

To ensure the long-term stable operation of the equipment, please maintain the equipment regularly (usually

every month) according to the operating environment.

a) The equipment is maintained by professionals.

b) Check whether the equipment is well grounded and safe.

c) Check whether there are potential safety hazards around the charging pile, such as whether there are high

temperature, corrosion or inflammable and explosive articles close to the charging station.

d) Check whether the join point of the input terminal is in good contact and whether there is any abnormality.

Check whether other terminal points are loose



---

## 6 Warranty agreement

1. The scope of warranty refers to the product itself.
2. The warranty period is 12 months. During the warranty period, the company will repair the product free of charge in case of failure or damage (determined by the company's technical personnel) under normal use.
3. The starting time of warranty period is the date of product manufacture.
4. Even in the warranty period, a certain maintenance fee will be charged in case of the following situations.
  - \* Equipment failure caused by not following the user's manual.
  - \* Equipment damage caused by fire, flood, abnormal voltage, etc.
  - \* Equipment damage caused by using the product for abnormal functions.
  - \* Equipment damage caused by foreign matter entering.
  - \* Equipment damage caused by other human external factors.
5. The service fee shall be calculated according to the actual cost. If there is another contract, the contract shall prevail.
6. Please be sure to keep this and show it to the maintenance personnel during the warranty period.
7. If you have any questions, please contact the agent or our company directly

---

Due to the TIMXON policy of continual product development, the details of our products and those mentioned in this manual are subject to change without notice. If you have any questions, please contact [service@timxon.com](mailto:service@timxon.com).